

Primary Characters

Word-initial character showing V_R Specification, Function, & Stem, plus V_V Designation & Version, plus all C_A information.

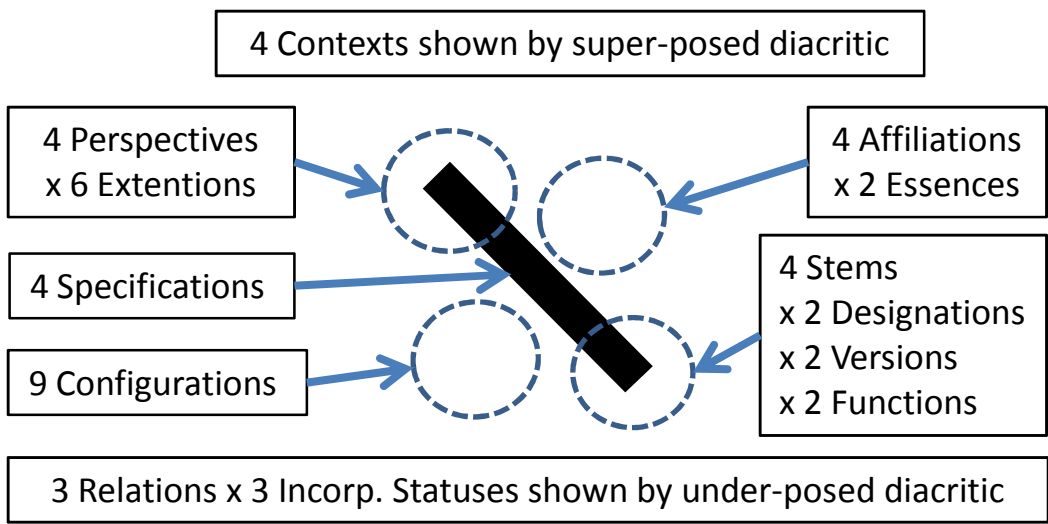
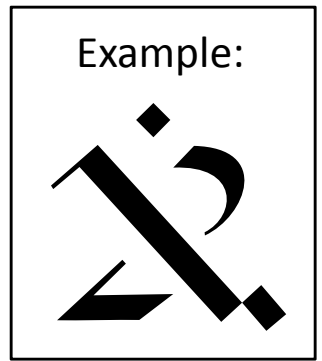

4 Contexts: EXS FNC RPS AMG

4 Specifications:

Handwritten forms shown in blue.

BSC or CTE CSV OBJ

4 Affiliations x 2 Essences:

NRM: CSL ASO VAR COA

RPV: CSL ASO VAR COA

9 Configurations:

UNI DPX DCT AGG SEG CPN COH CST MLT

4 Perspectives x 6 Extensions

	DEL	PRX	ICP	ATV	GRA	DPL
M						
P						
N						
A						

Primary Characters (cont'd)

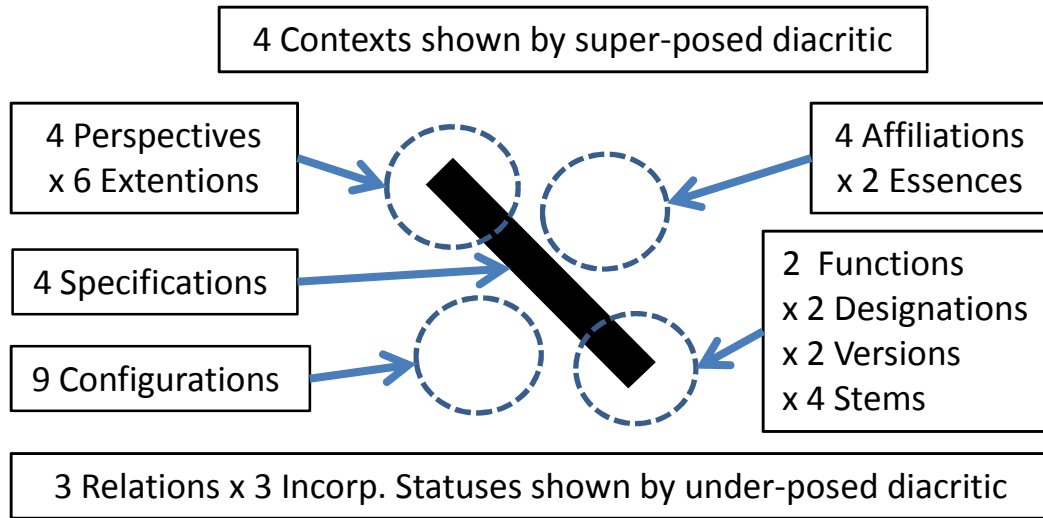

3 Relations x 3 Incorporation Statuses

	Simple Formative	Type 1 Incorporation	Type 2 Incorporation
Noun		↙	↘
Unframed Verb	◆	↘	↷
Framed Verb	▬	↘	↷

2 Functions x 2 Designations x 2 Versions x 4 Stems

Function	STA				DYN			
	IFL		FML		IFL		FML	
Designation	PRC	CPT	PRC	CPT	PRC	CPT	PRC	CPT
Version								
Stem 1	↙	↘	↙	↘	↙	↘	↙	↘
Stem 2	↙	↘	↙	↘	↙	↘	↙	↘
Stem 3	↙	↘	↙	↘	↙	↘	↙	↘
Stem "0"	↙	↘	↙	↘	↙	↘	↙	↘

NOTE: Any word-initial Primary Character consisting of a plain diagonal bar (i.e., a with "default" M/DEL/UNI/CSL/NRM/EXS/BSC/IFL/PRC/STA/Stem-1 on a simple nominal formative) may be elided if the word is in sentence-initial position.

Secondary Characters: Used for displaying C_R and C_S . The C_R character follows the word-Initial Primary character. The 27 forms below are the “core” characters, whose “top” and “bottom” ends then take extensions in order to prefix or suffix additional consonants shown on the next page.

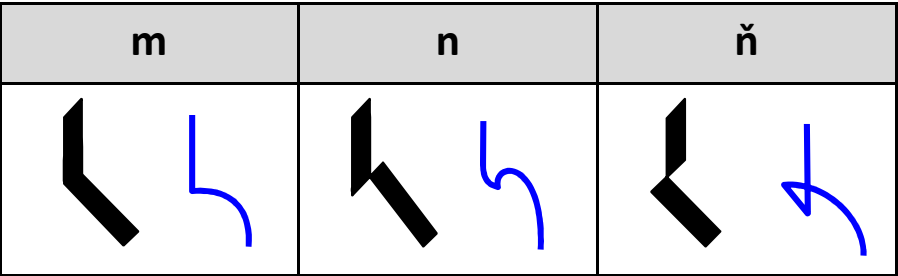
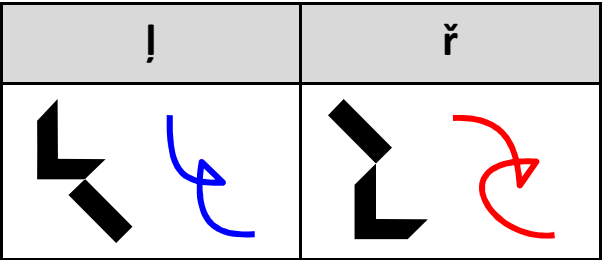
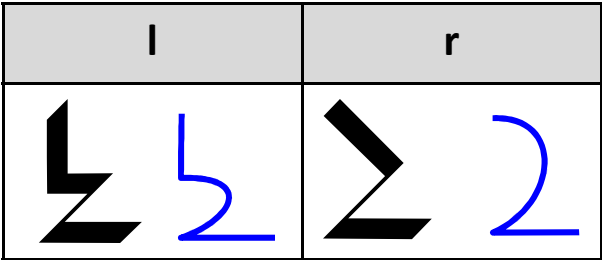
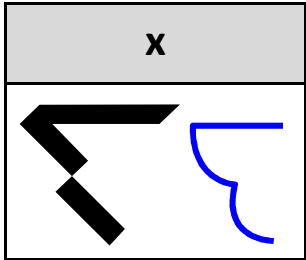
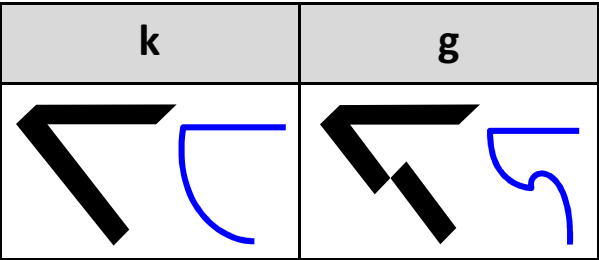
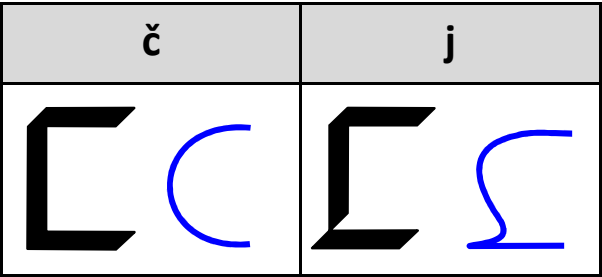
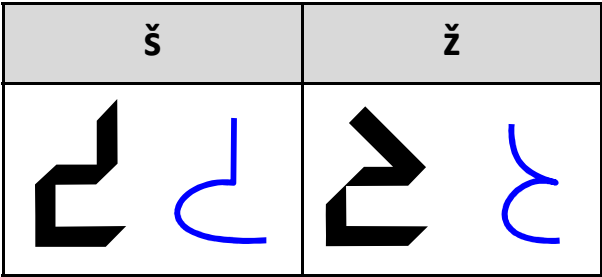
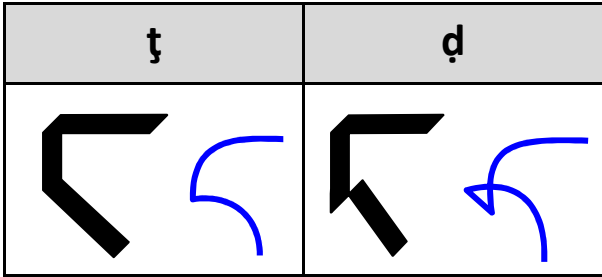
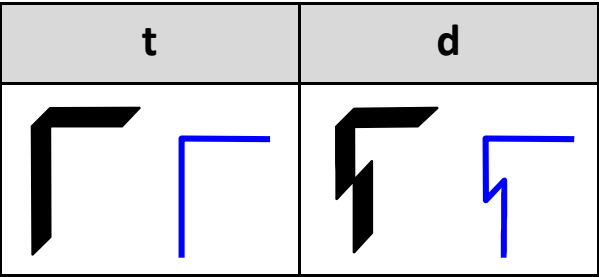
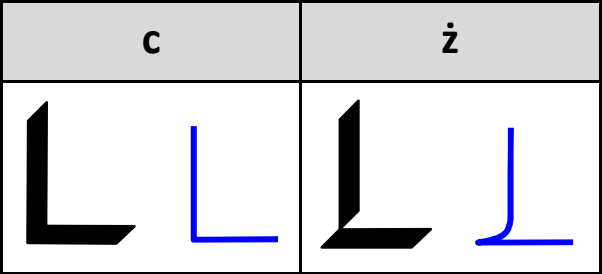
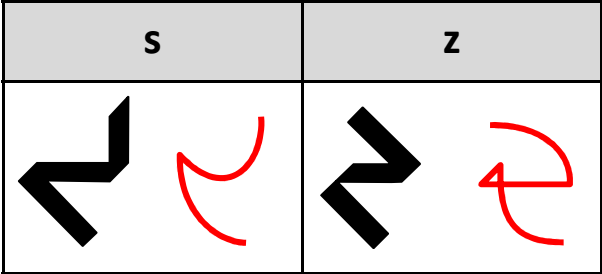
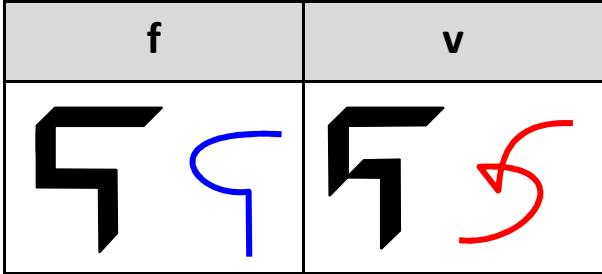
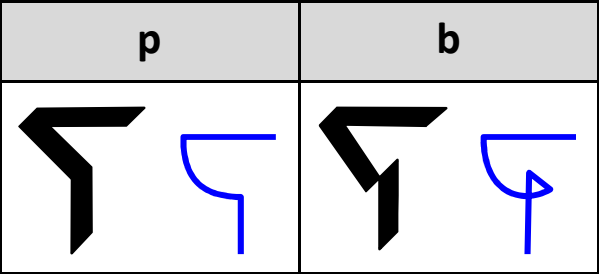

Handwritten forms shown in blue (changes since previous version shown in red). Note that the handwritten forms of both Primary and Secondary Characters have their diagonal segments curved inward or outward so that there are no diagonal end-points, only vertical or horizontal end-points.

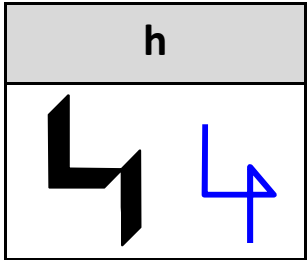

Consonantal Extensions to Secondary Characters: Applying these extensions to the upper “end” of a core consonant character adds a preceding consonant to that shown by the core character. Extensions applied to the lower “end” add a following consonant. Additional consonants may be added by applying these extensions to a “placeholder” character which, if used, immediately follows the consonantal character.

p	b	t	d	k	g	s	z
f	v	ʈ	ɖ	x	ř	š	ž

Placeholder Character:



Consonantal Extensions to Secondary Characters (cont'd):

m			
n			
ň			
l			
r			
j			

c	

z	

č	

j	

h	

w	

y	

gemination of main character	

gem. of other extension	

Examples:



kpw



mss

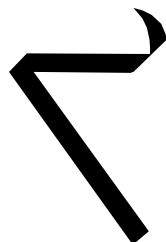

tkl

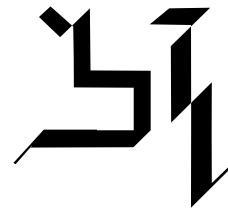

pfskr

Handwritten Extensions: As shown in the previous pages, the handwritten forms of Primary and Secondary Characters are designed so their “ends” are never diagonal (diagonal segments are curved to terminate as vertical or horizontal). Thus there is no need for handwritten diagonal extensions.

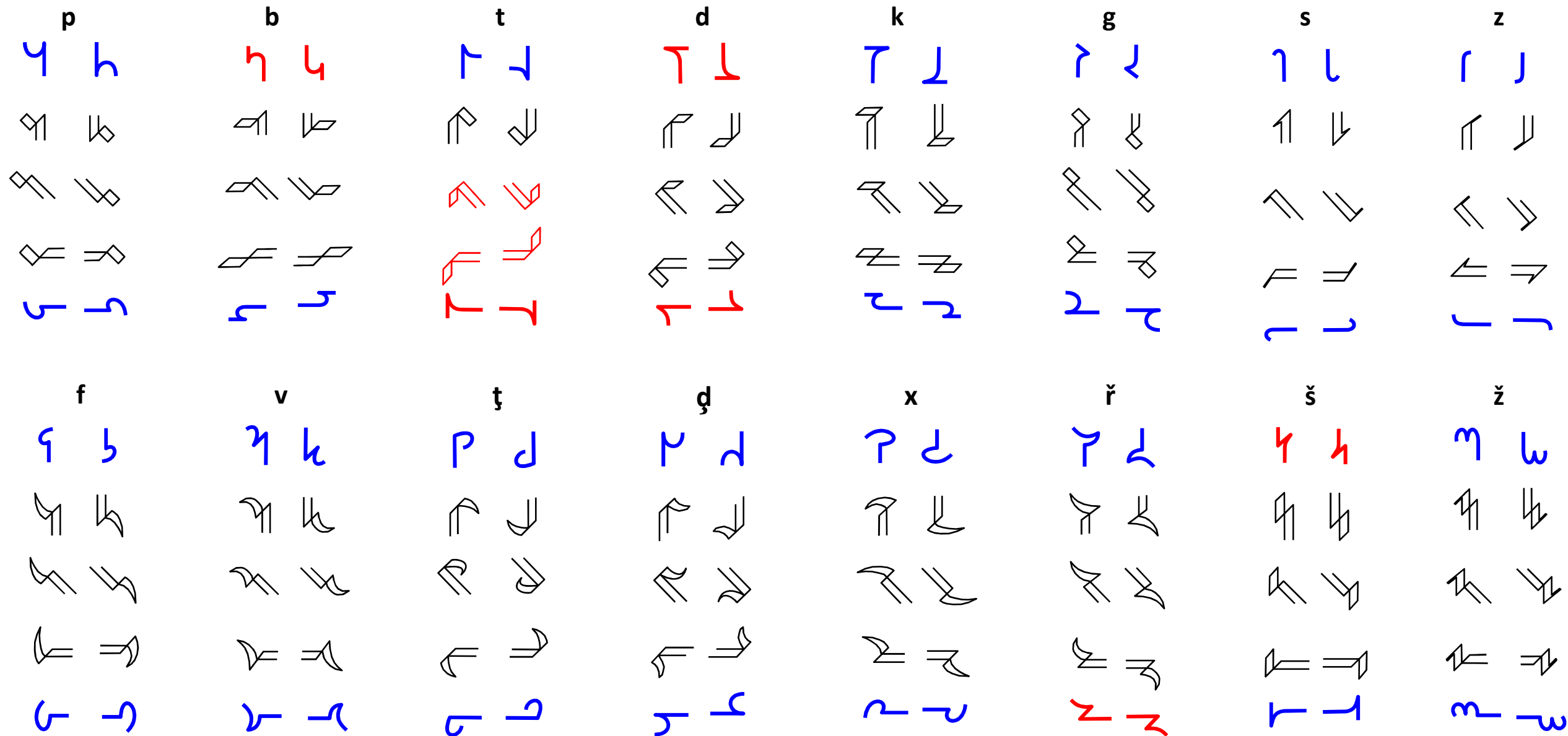

Handwritten Extensions (cont'd):

m	n	ň	l	r	l	w	y
c	z	č	j	h	[gem. 1]	[gem. 2]	

Alphabetic Writing:

Use Secondary Characters and their extensions plus the placeholder character for alphabetic writing of proper names and foreign words, preceded and followed by the appropriate double-dot diacritic (shown later in the Section on writing Register Adjuncts).

Additionally, use the diacritics shown below for vowels, placed above the character for a preceding vowel, under the character for a following vowel. Use the placeholder character (shown at left) for standalone vowels if necessary. Show 2-vowel conjuncts (including diphthongs) by superposing the first vowel diacritic on the placeholder character and underposing the second vowel diacritic. To show a single vowel between two single consonants, use the placeholder character with the two consonant extensions at top and bottom, with the vowel diacritic placed along the right side of the character.

a	ä	e	ë	i	o	ö	u	ü
◆	—	↗	↖	or \	⤵	⤴	↘	↙
•	—	↗	↖	\	⤵	⤴	↘	↙

Option to show 2-vowel conjuncts/diphthongs without using a placeholder character: To show a two-vowel conjunct or diphthong preceding a full-consonant conjunct, place the first vowel diacritic above the Secondary character and the second vowel diacritic along the right side. To show a following 2-vowel conjunct or diphthong, place the first vowel diacritic along the right side and the second vowel diacritic below the character.

Indicating Stress in Alphabetic Writing:

Penultimate stress is unmarked; otherwise, the stressed vowel should be shown on a stand-alone **plain vertical bar** shown here instead of the usual placeholder character.



Using Secondary Characters to show $V_x C_5$ affixes: Use the Secondary Characters with their extensions for any Slot VII C_5 character(s), placed immediately following the C_R character in simple formatives (the rules for complex formatives are given later in this document). Use the following underposed diacritics to show Degree:

$V_x C_5$: The character takes a underposed diacritic to show V_x Degree:											
1	2	3	4	5	6	7	8	9	C_A stacking	Degree "0"	
◆	↗	↘	☾	↙ or ↘	☾	↙	↖	▬	☾	☾	
•	↪	↳	↩	\	⤿	↰	↵	—	↻	↶	

To show Slot IX C_5 character(s): Place any Slot IX C_5 character(s) immediately after any Slot VII C_5 character(s) and mark the Slot IX C_5 character(s) with a dot diacritic placed “inside” the C_5 character (i.e., enclosed by any inner-angled section of the character).

To show Type-2 or Type-3 $V_x C_5$ affixes: These are shown using the Secondary Characters and extensions as the above affixes except that they are laterally rotated 180 degrees (i.e, they are upside-down but not horizontally inverted mirror-images). Additionally, Type-3 $V_x C_5$ affixes take a super-posed dot diacritic.

These rotated consonant characters are shown on the next page.

Showing Affixual Scoping: Indicating affixual scoping (beyond the use of Positive Delineation and Type-3 $V_x C_5$ affixes) in the spoken language requires the use of an affixual scoping adjunct (see Sec. 4.4 of the Design Document). However, the written language allows for a more succinct way to show detailed affixual scoping using diacritics placed along the right side of a Secondary C_5 character.

If a Slot VII C_5 character has scope over all other Slot VII affixes, use an outward-facing hook diacritic: ☾ For Slot XI C_5 characters, change the right-side dot diacritic to one of the following: (1) a vertical or slanting bar if the affix has scope over all $V_x C_5$ affixes, ↙ or ↘, (2) a horizontal bar if the affix has scope over the entire formative, ▬, or (3) an inward-facing hook if the affix has scope over the entire formative and all its other adjuncts, ☾.

Rotated Secondary Characters: These are identical to standard Secondary characters except they are laterally rotated 180 degrees. They are used to show any Type-2 V_xC_s affix(es). For a Type-3 V_xC_s affix, use these rotated characters plus an superposed dot.

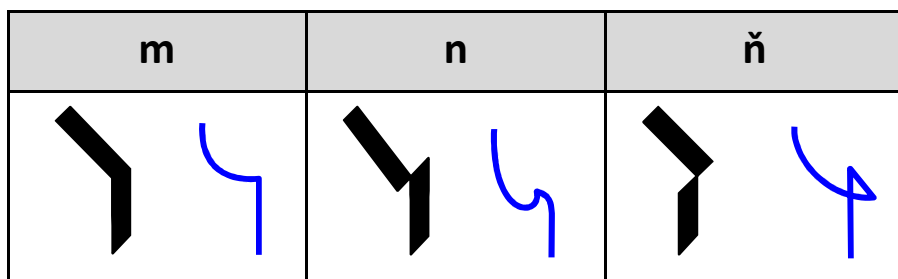
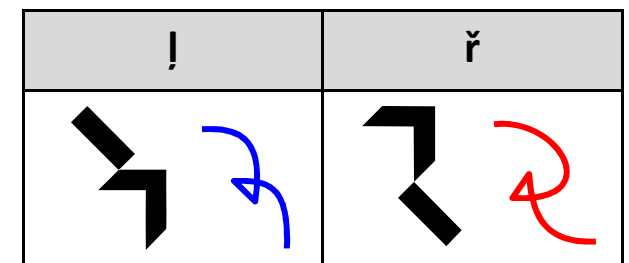
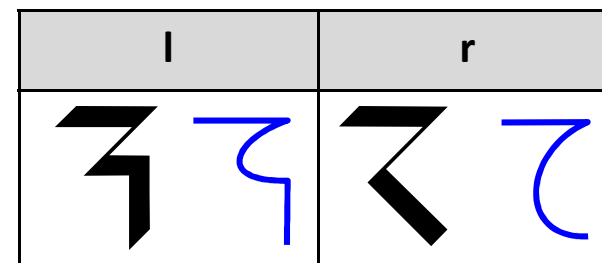
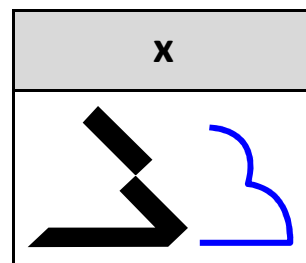
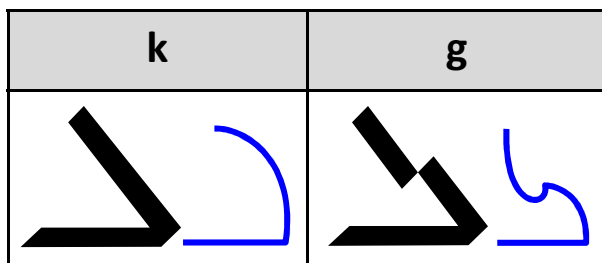
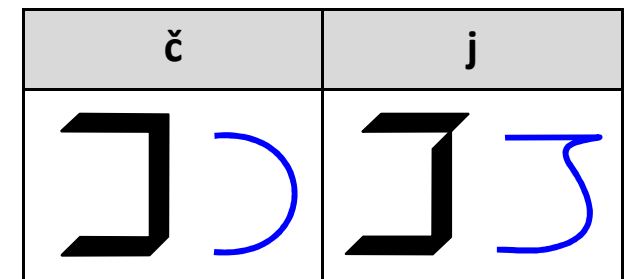
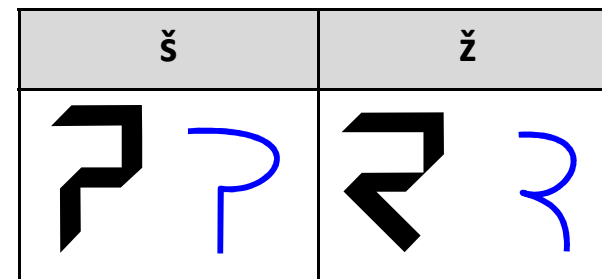
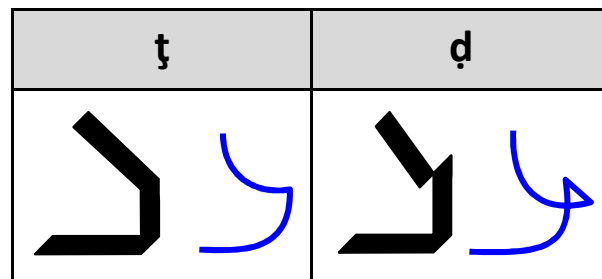
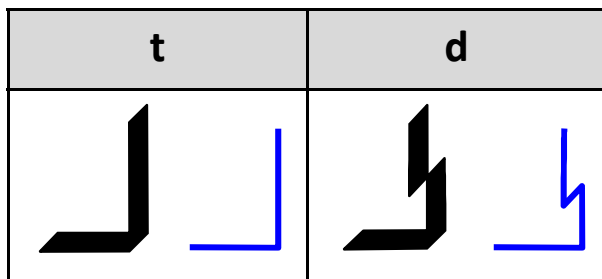
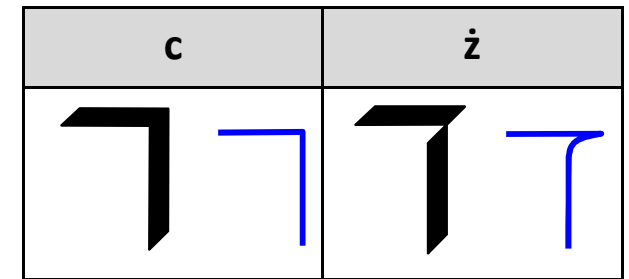
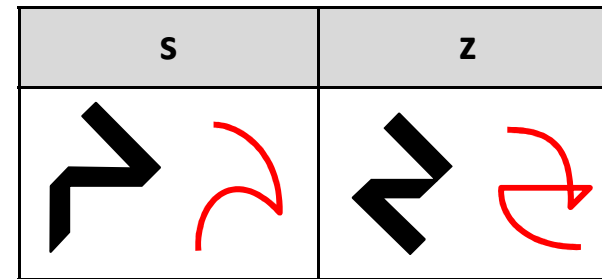
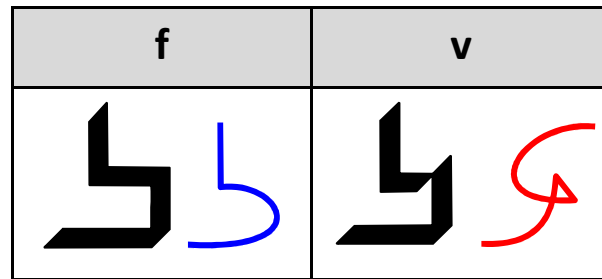
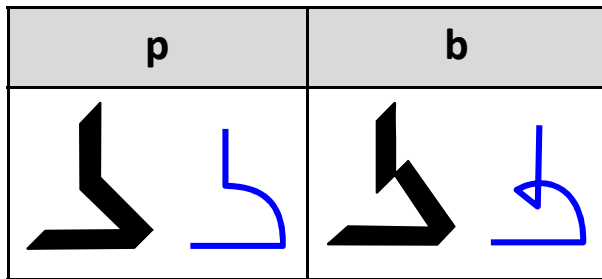

Positive Delineation: For any V_xC_s character that applies to an incorporated stem, show this via a superposed horizontal bar diacritic over the C_s character (rules for showing incorporated stems are shown later in this document); if there is already a superposed dot (indicating it is a Type-3 V_xC_s affix), change this dot to a vertical bar.

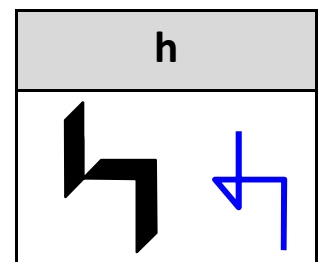

Tertiary Characters: Follows any Secondary Character; corresponds to Formative Slots X and XI to indicate Valence, Aspect, Phase, Effect, & Level

Character Form:

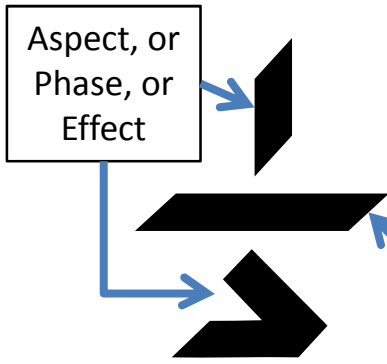

Effect:	neutral	1/BEN	2/BEN	3/BEN	all/BEN	UNKNOWN	all/DET	3/DET	2/DET	1/DET
Phase:	CTX	PCT	ITR	REP	ITM	RCT	FRE	FRG	FLC	
Valence:	MNO	PRL	CRO	RCP	CPL	DUP	DEM	CNG	PTI	IDC

NOTE: The horizontal Valence segment is mandatory. A Phase or Effect segment is also mandatory unless there are two aspects shown (one in upper half, one in lower half). A plain default CTX/MNO character is elided.

Aspect:

RTR	PRS	HAB	PRG	IMM	PCS	REG	ATC	ATP
RSM	CSS	PAU	RGR	PCL	CNT	ICS	SMM	IRP
PMP	CLM	DLT	TMP	MTV	SQN	EPD	PTC	PPR
DCL	CCL	CUL	IMD	TRD	TNS	ITC	XPD	LIM

Level: Shown by diacritic on Tertiary Character; superposed = Absolute, under-posed = Relative

MIN	SBE	IFR	DFC	EQU
◆	◀	↗	☾	↘ or ↙
SUR	SPL	SPQ	MAX	
☾	↗	↘	—	

Quaternary Characters -- V_C/V_K Characters:

Used for displaying V_C Case and V_K Illocution+Sanction, as well as C_M Mood and C_C Case-Scope. V_C and V_K are shown by extensions to the top and bottom ends of a plain vertical bar. Mood and Case-Scope are indicated by diacritics shown on the next page. A Quaternary Character is placed immediately after any Tertiary Character.

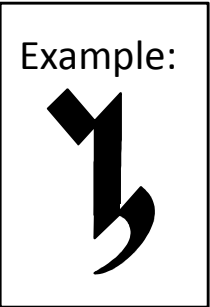

Illocution V_K:	CNF	INF	ITU	REV	HSY	USP	DIR	IRG	DEC
Case V_C:									
Type:	TRANSRELATIVE	APPOSITIVE	ASSOCIATIVE	ADVERBIAL	SPATIO-TEMP I	SPATIO-TEMP II	RELATIONAL I	RELATIONAL II	

Sanction V_K:	PPS	EPI	ALG	IPU	RFU	REB	CJT	EXV	AXM	(null)
Case V_C:										
Case No.	1	2	3	4	5	6	7	8	9	

Handwritten forms of Quaternary characters follow the same patterns as vertical consonant extensions.

Diacritics Used with Quaternary Characters

CASE-SCOPE:						
Shown via an underposed diacritic below a Quaternary Character:	CCh	CCl	CCr	CCw	CCm	CCn
		◆	◄ or ◂	↷	↶	▬
MOOD:						
Shown via a superposed diacritic above a Quaternary Character:	FAC (or zero)	SUB	ASM	SPC	COU	HYP

Case-Assessor Affixes: These are composed of a Quaternary Character indicating Case, accompanied by special diacritics.

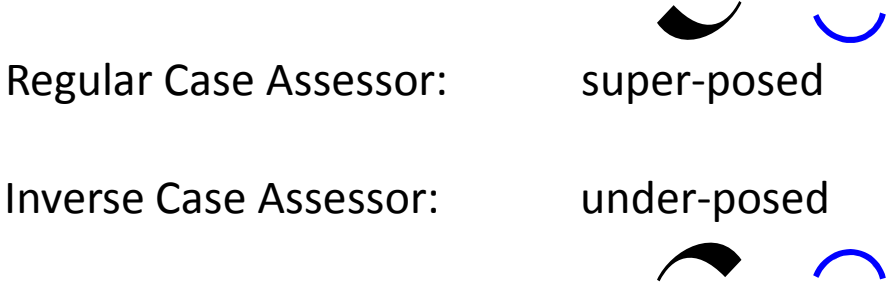

Case-Stacking: A second case, with scope over the first, is shown by simply adding a 2nd Quaternary Character immediately after the first.

Complex Formatives -- How To Show V_I , C_I and V_F Information for an Incorporated Stem:

To show an incorporated Stem, use a Primary Character to show the Slot IV V_I info for the incorporated root, placed immediately following the C_R Secondary Character and before any C_S Secondary Characters (the diacritic below the word-initial Primary Character already alerts the reader to expect a 2nd Primary Character following C_R). Any C_A info shown on this character is to be interpreted as applying to the incorporated stem before any affixes. If, instead, C_A info for the incorporated stem is to apply after other $V_x C_S$ affixes are applied, use a positively-delineated Secondary Character instead in the "Slot IX" position.

This 2nd Primary Character will be immediately followed by the Slot V C_I root, shown by a Rotated Secondary Character plus extensions (this rotated consonantal character cannot be mistaken for a Type-2 or Type-3 $V_x C_S$ affix because it will have no underposed V_x diacritic).

The C_I root character will in turn be followed by a modified Quaternary V_C/V_K Character to show Slot VI V_F Format. These modified Quaternary Characters for showing Format are shown below (standard Quaternary Case characters are shown above them in grey for purposes of comparison):

Case V_C :									
Type:	TRANSRELATIVE	APPOSITIVE	ASSOCIATIVE	ADVERBIAL	SPATIO-TEMP I	SPATIO-TEMP II	RELATIONAL I	RELATIONAL II	
Format V_F :									
Case V_C :									
Case No.	1	2	3	4	5	6	7	8	9
Format V_F :									

Alternative To Using Quaternary Characters – Showing Case or Format Using Diacritics on the C_R or C_I Root Characters

If Mood and Case-scope are default **FAC/CCh** (so that there are no diacritics above or below the Quaternary **V_C/V_K** Character), then the option exists to dispense with the Quaternary character and instead show Case on the **C_R** consonantal root character using the superposed and underposed diacritics shown below.

These same diacritics may also be used on the **C_I** consonantal root character to show Format of an incorporated stem instead of using the modified Quaternary Format character shown on the previous page.

Super-posed:



Type: TRANSRELATIVE APPOSITIVE ASSOCIATIVE ADVERBIAL SPATIO-TEMP I SPATIO-TEMP II RELATIONAL I RELATIONAL II

Case No. 1 2 3 4 5 6 7 8 9

Under-posed:



Alternative To Using Quaternary Characters – Showing Illocution+Sanction Using Diacritics on the C_R Root Character

Just as nominal formatives may show Case via diacritics on the C_R Root Character If Mood and Case-scope are default **FAC/CCh**, so verbal formatives may show Illocution + Sanction via diacritics on the C_R Root Character.

Super-posed:

Illocution V_k:

CNF INF ITU REV HSY USP DIR IRG DEC

Sanction V_k:

PPS EPI ALG IPU RFU REB CJT EXV AXM (null)

Under-posed:

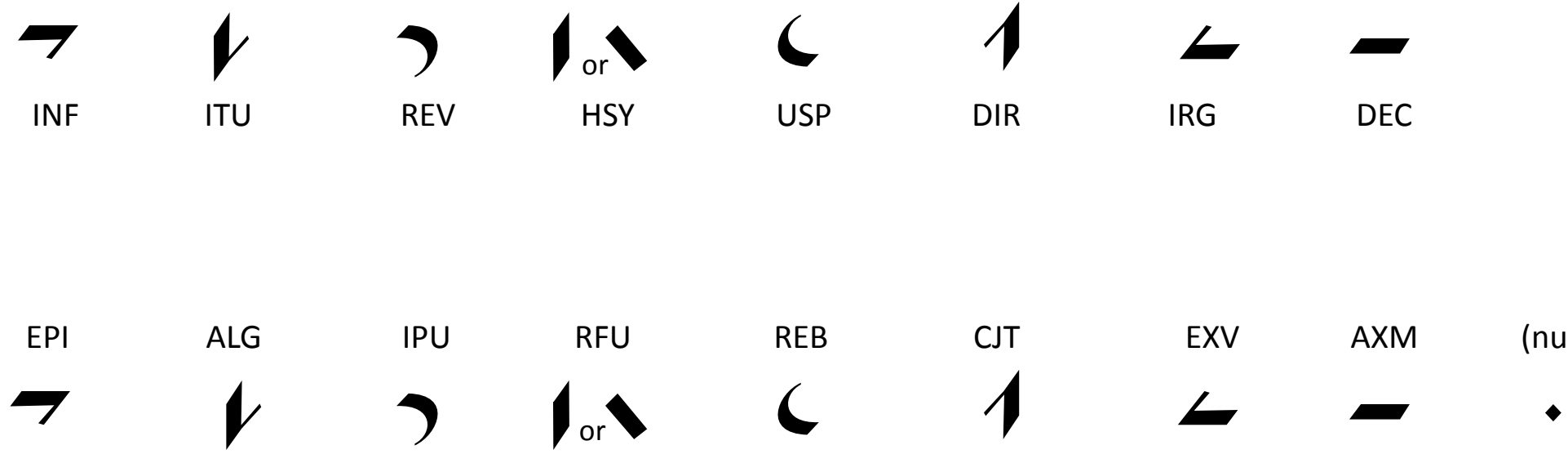

Character Type 5 -- Bias Characters

Placed in word-final position, the various Bias categories (once they are available) will be shown via modification of the top and bottom ends of the characters shown here:

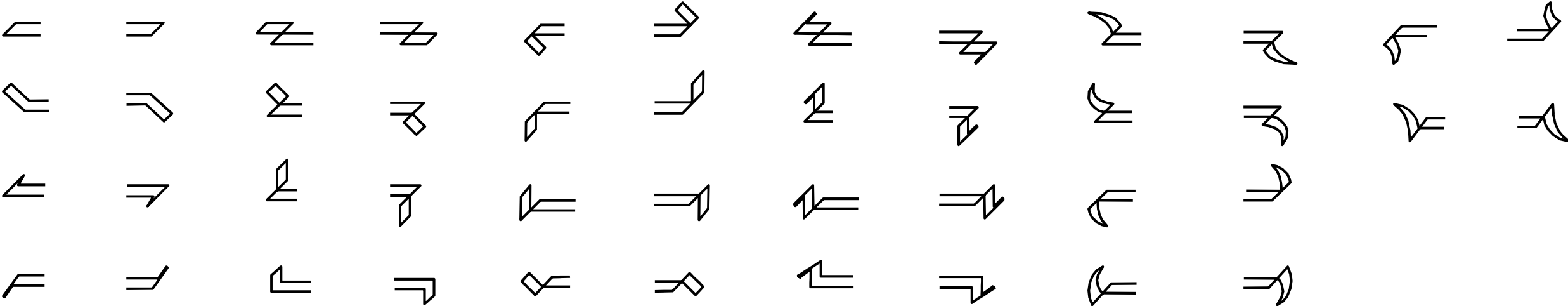

Showing Personal Reference Adjuncts

To show a personal reference adjunct, use a Quaternary Character followed by a Secondary Character (with extensions if needed) to indicate the specific personal referent(s) with a superposed horizontal bar diacritic. Dual-referent adjuncts are written as two single-referent adjuncts next to each other (as in Ithkuil). For verbalized personal-reference adjuncts (i.e., those containing V_K Illocution+Sanction information as well as Case, use a second quaternary character showing V_K plus a dot diacritic along its right side; place this V_K character between the first (case) quaternary character and the Secondary consonant character.

Showing Register

The following symbols are placed before and after a phrase to mark various registers. Each register has four modes; the first indicating register only, while the second mode indicates that the word within the register phrase is written alphabetically (i.e., it is a proper name or foreign word/phrase). For the third and fourth modes, see next page.

	Standard	Alphabetic	Transcriptive*	Translitative*
Narrative:		◆ ◆ : ◆ ◆	◆ ◆ ◆ ◆ : ◆ ◆ ◆ ◆	◆ ◆ ◆ ◆ > ◆ ◆ ◆ ◆
Parenthetical:	◆ ◆ ◆ ◆ ◆ ◆	◆ ◆ ◆ ◆ ◆ ◆	◆ ◆ ◆ ◆ ^ ◆ ◆ ◆ ◆	◆ ◆ ◆ ◆ v ◆ ◆ ◆ ◆
Cogitant:	◆ ◆ ◆ ◆ ◆ ◆	◆ ◆ ◆ ◆ ◆ ◆	◆ ◆ ◆ ◆ s ◆ ◆ ◆ ◆	◆ ◆ ◆ ◆ s ◆ ◆ ◆ ◆
Exemplificative:	◆ ◆ ◆ ◆ ◆ ◆	◆ ◆ ◆ ◆ ◆ ◆	◆ ◆ ◆ ◆ ~ ◆ ◆ ◆ ◆	◆ ◆ ◆ ◆ ~ ◆ ◆ ◆ ◆
Specificative :	◆ ◆ ◆ ◆ ◆ ◆	◆ ◆ ◆ ◆ ◆ ◆	◆ ◆ ◆ ◆ m ◆ ◆ ◆ ◆	◆ ◆ ◆ ◆ m ◆ ◆ ◆ ◆

* see next page

Transcriptive & Translitative Modes: The Phonetic Representation (or Suppression) of Adjuncts

Being a morpho-phonemic writing system, the script does not normally represent adjuncts (other than personal-reference adjuncts). Consequently, a written passage may have different spoken interpretations by a reader, i.e., it is left up to the reader whether to utilize adjuncts or not when reading aloud a written passage in the language.

Nevertheless, in certain circumstances such as when reading poetry or song lyrics, reading the script of a play, a direct quote, or a word-for-word transcription, it becomes desirable to indicate to the reader exactly how a written passage is to be read aloud. This is the purpose of the Transcriptive and Translitative modes.

Transcriptive Mode indicates that the word/phrase inside the markers is to be read exactly as standardly written, i.e., without using adjuncts (other than personal-reference adjuncts).

Translitative Mode indicates the word/phrase within the markers is one of the following: (1) a phonemic rendering of an adjunct written using Secondary Characters written alphabetically, (2) a Tertiary Character representing a Modular Adjunct, to be read Valence first, then the top “half”, then the bottom “half”, or (3) a Bias Character, representing a consonantal Bias Adjunct.

Additional Characters for Alphabetic Writing

The following character-shape is utilized in multiple ways as a means of representing foreign words/sounds when writing alphabetically:



The following extensions on the above character shape indicate secondary vocalic articulations. The top bar of the shape may take a Secondary Character consonantal extension. Additionally, vowel diacritics may be applied above and below these shapes.

Long Vowel



Nasalization



Pharyngealization

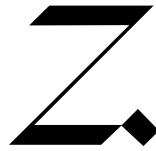

Breathy Voice/Whispered



Creaky Voice

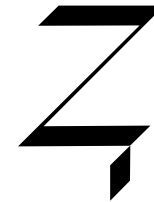

Tones:

High



Mid



Low



Rising



Falling



Combination tones are shown by using two markers on the character, e.g.,

Low-Rising:



Falling-Rising:



Use the following bottom extensions on a Secondary place-holder character (with a standard consonantal top extension if applicable):

Glottal Stop:

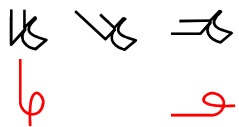

Ejective Consonant:



Velarized/Pharyngealized Consonant:

















Sequence of Written Characters for Simple Formatives



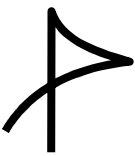





Type 1 Primary Character	Type 2 Consonantal character	Type 2 Consonantal character(s)	Type 2 Consonantal character(s)	Type 3 Valence Character	Type 4 V_C/V_K Character	Type 5 (Bias) Character
Stem, Specification, Function, Designation, Version, C_A	C_R Main Root	C_S (Slot VII)	C_S (Slot IX)	Valence, Phase, Effect, Aspect, Level	V_C/V_K plus Mood and/or Case-Scope	C_B

Sequence of Written Characters for Complex Formatives

Type 1 Primary Character	Type 2 Consonantal character	Type 1 Primary Character	Type 2 Consonantal character	Type 4 V_C/V_K Character (modified)	Type 2 Consonantal character(s)	Type 2 Consonantal character(s)	Type 3 Valence Character	Type 4 V_C/V_K Character	Type 5 (Bias) Character
Stem, Specification, Function, Designation, Version, C_A of main root	C_R Main Root	Stem, Specification, Function, Designation, Version, C_A of incorp. root	C_I Incorporated Root	V_F Format of Inc. Stem	C_S (Slot VII type)	C_S (Slot IX type)	Valence, Phase, Effect, Aspect, Level	V_C/V_K Mood, Case-Scope	C_B

Writing Numerals

1	2	3	4	5	6	7	8	9	0	100	10,000	100 ⁴	100 ⁸
													

Written								
+10	+20	+30	+40	+50	+60	+70	+80	+90
-----	-----	-----	-----	-----	-----	-----	-----	-----
-----	-----	-----	-----	-----	-----	-----	-----	-----
								

Legacy (or “Ithkuil Traditional”) Style: a non-calligraphy-friendly font in which beveled vertices are instead pointed, diagonal stroke-ends are horizontally flattened (if the resulting inside angles are acute rather than obtuse), and diagonal strokes are equally thick regardless of direction, e.g.,

